

Muncie PTO brought to you by Pro Gear & Transmission

REBUILT MUNCIE PTO

877-776-4600 | 407-872-1901



For Muncie PTO parts or service call Pro Gear & Transmission, Inc.
877-776-4600 / 407-872-1901 | parts@eprogear.com



GA6B & GM6B SERIES POWER TAKE-OFF

PARTS LIST



FOR THE ALLISON 1000 & 2000 SERIES
AUTOMATIC TRANSMISSION

GM6B & GA6B SERIES PTO

EXPLODED VIEW

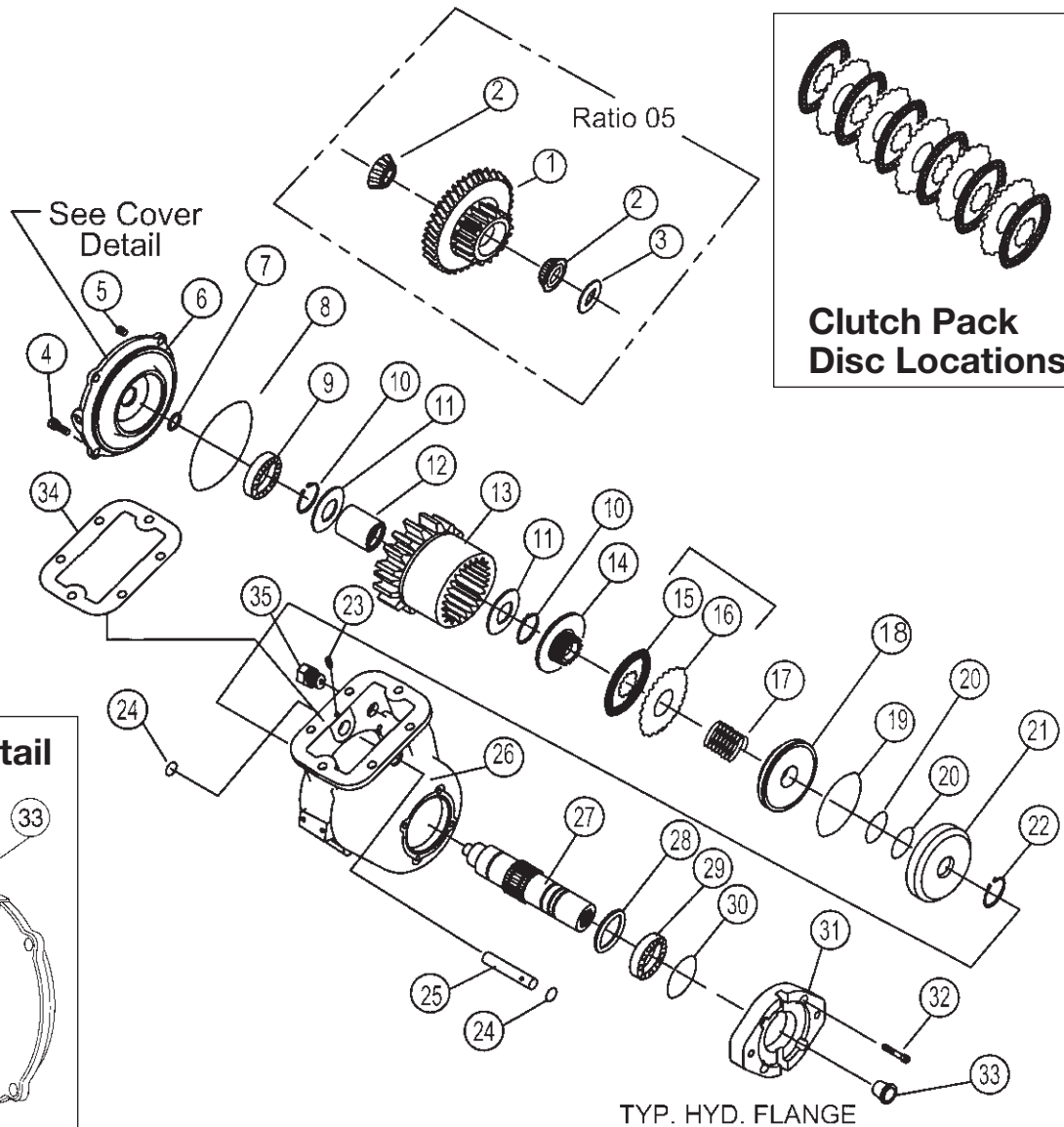

MODEL NUMBER CONSTRUCTION

GA 6B - A68 05 - H 1 T X

PTO Type

Clutch Shift (Standard) — GA
 **Clutch Shift Less Activation Kit — GM
 (Used with 48TK4415 Installation Kit w/Shield & Activation Kit)

Mounting

6 Bolt Standard Metric — 6B

Trans. CS Gear Data

Allison 6.86P 20°PA Spur — A68

Special Feature

X — None

Output Type

T — SAE "A" 2 Bolt

Assembly Arrangement

1

Shifter Type

H — Electric/Hydraulic (12 Volt)

Speed Ratio

05 — .47:1

***GM6B is PTO Unit only. Mounting Kit, Activation Kit, and Heat Shield Kit are sold separately. (See back page)*

SERVICE PARTS LIST AND DESCRIPTION

GA6B-A6805-H1TX • GM6B-A6805-H1TX

ITEM	QTY	PART NUMBER	DESCRIPTION
NS	2	25T37702	Capplug
1	1	03T37351	Gear
2	2	10T37736	Bearing
*3	1	18T35783	Shim (.115/.113)
	1	18T35782	Shim (.120/.118)
	1	18T35781	Shim (.125/.123)
	1	18T36230	Shim (.130/.128)
	1	18T36229	Shim (.135/.133)
	1	18T37151	Shim (.140/.138)
	1	18T37152	Shim (.145/.143)
	1	18T37153	Shim (.150/.148)
4	4	19T35237	Capscrew
5	2	25T21684	Pipe Plug
6	1	15T37350	Cover
7	1	12T36081	O-Ring
8	1	12T34003	O-Ring
9	1	10T21017	Bearing
10	2	24T35480	Snapring
11	2	21T29017	Race
12	1	10T37008	Bearing
13	1	02T37352	Gear
14	1	02T37338	Clutch Hub

ITEM	QTY	PART NUMBER	DESCRIPTION
15	6	49T37345	Clutch Friction Disk
16	5	49T37346	Clutch Stator
17	1	27T36112	Spring
18	1	49T37347	Piston
19	1	12T36186	O-Ring
20	2	12T36471	O-Ring
21	1	49T37348	Cup
22	1	24T36470	Snapring
23	1	19T35785	Setscrew
24	2	12T35774	O-Ring
25	1	07T37071	Shaft-Input
26	1	01T37259	Housing
27	1	06T37953	Shaft-Output
28	1	18T37737	Spacer
29	1	10T37229	Bearing-Sealed
30	1	12T36277	O-Ring
31	1	14T37735	Flange
32	4	19T33233	Capscrew-Hex Head
33	1	25T37387	Capplug
34	2	13M13541	Mounting Gasket
35	1	25T37761	SAE Reducer
36	2	25T21684	Pipe Plug

*One Shim used as required for correct bearing load. .002" to .006" loose.

GA6B & GM6B SERIES DIMENSIONS

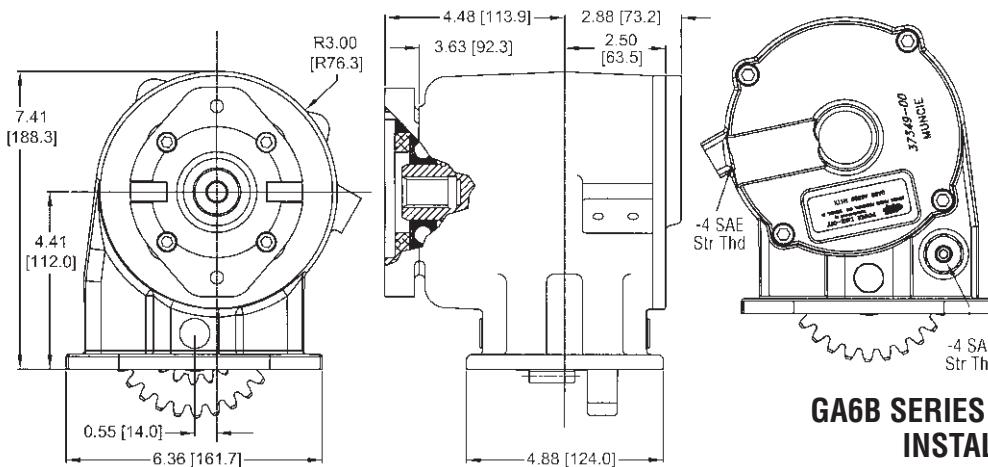

48TK4212 GA6B-A68 PTO KIT

QTY	PART NO.	DESCRIPTION
1	52MK1009	Gasket
		Instruction Pack
1	20TK4058	Stud Kit (see p4)
1	36MK3841	Safety Labels
1	48TK4211	Installation Kit GA Series (Content Below)

GA6B SERIES ELECTRIC/HYDRAULIC SHIFT INSTALLATION KIT 48TK4211

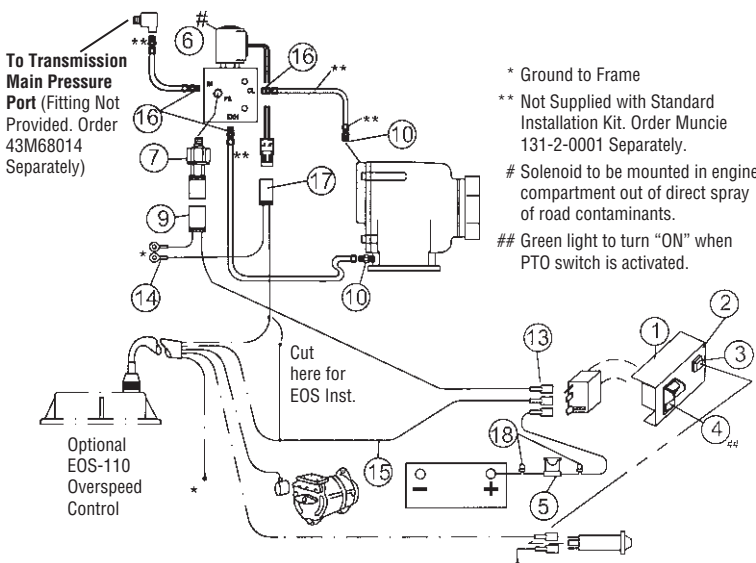

ITEM	QTY	PART NO.	DESCRIPTION
		30T36270	Switch Ass'y 12V (Incl. 1,2,3,4)
1	1	36MA1005	Switch Bracket
2	1	36M01006	Face Plate w/Light Access
3	1	36T36271	Face Plate w/o Light Access
4	1	30T35687	Rocker Switch 12V
N.S.	1	36MK1007	Mtg. Hardware (w/Switch Kit)
5	1	33T36299	Fuse Assembly
6	1	35T37928	12V Solenoid Valve (Service Parts see page 4)
7	1	30T37954	Pressure Switch
9	1	34T36941	Wiring Pigtail
10	2	43T36431	Straight, Adapter ODT to JIC
13	3	34M18250	Female Spade Connector
14	2	34M18009	Ring Terminal
15	12	37M18000	Electric Wire 12ft.
16	3	43M68014	Elbow, Adapter ODT to JIC
17	1	34MA1415	Wire Harness Connector
18	2	34T36362	End Crimp Connector
N.S.	2	19T36623	Solenoid Mounting Capscrew

GM6B INSTALLATION KITS

INSTALLATION KITS FOR GM6B PTO - SOLD SEPARATELY

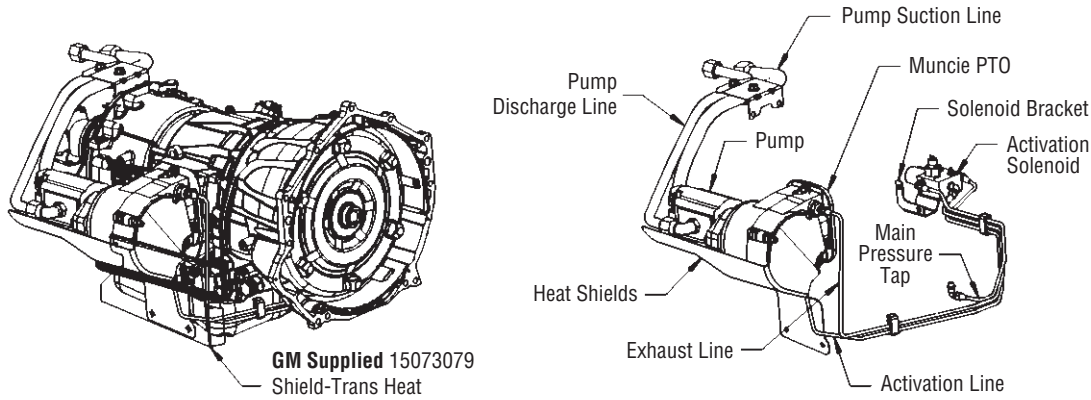

GM6B-A6805-H1TX

(for complete installation instructions see IN01-03 manual)

48TK4962 INSTALLATION KIT

(Model Year 2007 & Later)

TUBING/SHIELD USED WITH GM6B PTO

48TK4963 INSTALLATION KIT

(Model Year 2007 & Later)

INCLUDED IN 48TK4962

QTY	PART NO.	DESCRIPTION
1	49T38282	Bracket Solenoid
1	49T38269	Bracket
1	49T38268	Tubing Suction
1	49T38253	Tubing Discharge
1	49T38270	Tubing Engage
1	49T38281	Tubing Pressure
1	49T38280	Tubing Vent
1	49TK4860	Shield Kit
1	48TK4963	Kit (Content at Right)

QTY	PART NO.	DESCRIPTION
1	52MK1009	Gasket Kit
1	20TK4058	Stud Kit
1	35T37928	Solenoid Valve
1	30T37954	Press. Switch - 12v
1	36MK3841	Label Packet-English
1	22T38325	Nut-U
1	49T38322	Clamp
1	49T38393	Clamp
1	49T38295	Bracket
4	43M68014	Adapter-Hydraulic 90
1	43T38323	Adapter-Hydraulic 90

QTY	PART NO.	DESCRIPTION
1	43T38392	Adapter-Hydraulic 90
2	43T36431	Adapter-Hyd. Straight
2	19T37726	Hex Head Bolt
2	22T21723	Nut
3	19T37440	Bolt
2	19T36623	Bolt
2	22MX2520	Nut
1	30T38371	Switch
1	34T40692	Wire Harness
1	49T38294	Shield
3	21T23153	Washer
1	13M13541	Gasket

48TK4415 Installation Kit for GM Model Year 2001-2006

GA6 & GM6 ASSEMBLY

FOR PROPER INSTALLATION AND ADJUSTMENT OF THE TAPERED INPUT BEARINGS

- Lubricate bearings and races with lithium based bearing grease.
- Place input bearing into input gear and slide this group into housing to line up idler shaft.
- Tap idler shaft into housing and through both bearing races.
- Tap idler shaft in the reverse direction so that it is flush with bearing in this assembly. Insert the thickest shim that can be installed **by hand** in the gap between bearing and housing. Rotate input gear to ensure it is not excessively tight or loose. Recommended bearing pre-load is .002 loose to .006 loose. *Note the location of Shim in Step 4 of diagram is on opposite side of gear than set screw.*
- Tap idler shaft into position and install set screw.

Shim	Tolerance
18T35783	.115/.113
18T35782	.120/.118
18T35781	.125/.123
18T36230	.130/.128
18T36229	.135/.133
18T37151	.140/.138
18T37152	.145/.143
18T37153	.150/.148

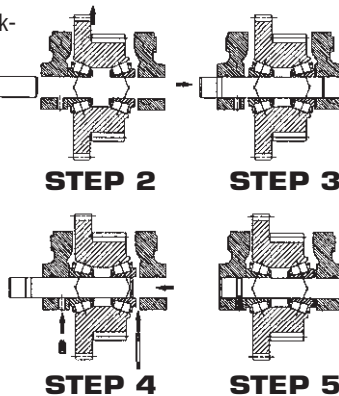

20TK4058 STUD KIT FOR GA6B OR GM6B SERIES

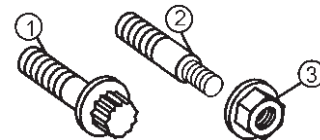

ITEM	QTY	PART NO.	DESCRIPTION
1	2	19T35778	10mm Capscrew
2	4	20T37952	10mm Step Stud
3	4	22T37605	Whiz-Lock Nut

35T37928 SOLENOID VALVE

35T36092 Replacement Cartridge Contains the Following:

QTY	PART NO.	DESCRIPTION
1	22T36498	Retaining Nut
1	37T36496	12v Coil
1	35T37997	Valve Stem
1	12TK3902	Seal Kit



Muncie Power Products, Inc. Member of the Interpump Hydraulics Group
 General Offices and Distribution Center • P.O. Box 548 • Muncie, IN 47308-0548
 (765) 284-7721 • FAX (765) 284-6991 • E-mail info@munciepower.com
 Web site http://www.munciepower.com



Pro **Gear**

AND TRANSMISSION, INC.

If you have any questions about any Munice Product, do not hesitate to call us so we can help you with finding the right PTO, part or anything else you may need.

906 West Gore St
Orlando, FL 32805
USA

Contact Us:

1-866-776-4600

1-407-872-1901

Fax:

1-407-872-6235